

SP 1500 S

Deflection mirror

- Not more than one safety light curtain / -grid necessary
- For the realization of circumferential protections up to 4 sides
- Angular orientation adjustable using two supplied brackets
- Special models equipped with a protective anti-fragmentation film on the mirrors available on request
- Optical power reduction factor 15% for each mirror
- Extruded aluminium section bar



Safety instructions

All the installation, connection and safety regulations, as per our technical information, have to be strictly adhered to.
The set-up of the products have to be made by skilled staff, only.
Repair exclusively made by di-soric.

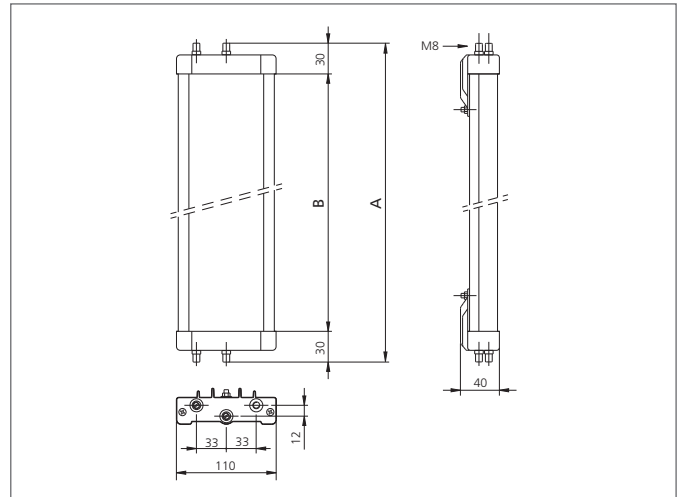

TECHNICAL INFORMATION (typ.)

Total height (A)	1.660 mm
Operating principle	Deflection mirror
Ambient temperature	-10 ... +55 °C (mirrors)
For	1.510 mm protective field height
Casing material	aluminium extrusion poles, epoxy powder coated, plastics
Model	freely adjustable
Scope of delivery	assembly instruction, 2 adjustable fixing brackets, Fixing material
Optical power reduction factor	15 %
Deflection mirror height (B)	1.600 mm